



DEPARTMENT OF REGULATORY AND ECONOMIC RESOURCES (RER)
BOARD AND CODE ADMINISTRATION DIVISION

MIAMI-DADE COUNTY
PRODUCT CONTROL SECTION
11805 SW 26 Street, Room 208
Miami, Florida 33175-2474
T (786) 315-2590 F (786) 315-2599

NOTICE OF ACCEPTANCE (NOA)

www.miamidadegov/economy

Shutter Tech, Inc.
7485 West 2nd Court
Hialeah, FL 33014

SCOPE:

This NOA is being issued under the applicable rules and regulations governing the use of construction materials. The documentation submitted has been reviewed and accepted by Miami-Dade County RER- Product Control Section to be used in Miami Dade County and other areas where allowed by the Authority Having Jurisdiction (AHJ).

This NOA shall not be valid after the expiration date stated below. The Miami-Dade County Product Control Section (In Miami Dade County) and/or the AHJ (in areas other than Miami Dade County) reserve the right to have this product or material tested for quality assurance purposes. If this product or material fails to perform in the accepted manner, the manufacturer will incur the expense of such testing and the AHJ may immediately revoke, modify, or suspend the use of such product or material within their jurisdiction. RER reserves the right to revoke this acceptance, if it is determined by Miami-Dade County Product Control Section that this product or material fails to meet the requirements of the applicable building code.

This product is approved as described herein, and has been designed to comply with the High Velocity Hurricane Zone of the Florida Building Code.

DESCRIPTION: Maximum Impact 0.050" Aluminum Storm Panel Shutter

APPROVAL DOCUMENT: Drawing No. 98002, titled "Maximum Impact .050 Aluminum Storm Panel", sheets 1 through 7 of 7, prepared by Ramms Engineering, Inc., dated January 10, 1998, last revision dated July 14, 2017, signed & sealed by Robert Monsour, P.E., bearing the Miami-Dade County Product Control Revision stamp with the Notice of Acceptance number and the expiration date by the Miami-Dade County Product Control Section.

MISSILE IMPACT RATING: Large and Small Missile Impact Resistant

LABELING: Each panel shall bear a permanent label with the manufacturer's name or logo, city, state, the following statement: "Miami-Dade County Product Control Approved", and NOA number, per TAS-201, TAS-202, and TAS-203, unless otherwise noted herein.

RENEWAL of this NOA shall be considered after a renewal application has been filed and there has been no change in the applicable building code negatively affecting the performance of this product.

TERMINATION of this NOA will occur after the expiration date or if there has been a revision or change in the materials, use, and/or manufacture of the product or process. Misuse of this NOA as an endorsement of any product, for sales, advertising or any other purposes shall automatically terminate this NOA. Failure to comply with any section of this NOA shall be cause for termination and removal of NOA.

ADVERTISEMENT: The NOA number preceded by the words Miami-Dade County, Florida, and followed by the expiration date may be displayed in advertising literature. If any portion of the NOA is displayed, then it shall be done in its entirety.

INSPECTION: A copy of this entire NOA shall be provided to the user by the manufacturer or its distributors and shall be available for inspection at the job site at the request of the Building Official.

This NOA **revises & renews** NOA #15-0714.22 and consists of this page 1, evidence submitted pages E-1, E-2, E-3 & E-4 as well as approval document mentioned above.

The submitted documentation was reviewed by **Helmy A. Makar, P.E., M.S.**



Helmy A. Makar
10/19/2017

NOA No. 17-0925.04
Expiration Date: 10/22/2022
Approval Date: 10/19/2017
Page 1

Shutter Tech, Inc.

NOTICE OF ACCEPTANCE: EVIDENCE SUBMITTED

1. EVIDENCE SUBMITTED UNDER PREVIOUS APPROVALS

A. DRAWINGS

See NOA 01-0718.09

B. TESTS

See NOA 01-0718.09

C. CALCULATIONS

See NOA 01-0718.09

D. MATERIAL CERTIFICATIONS

See NOA 01-0718.09

E. STATEMENTS

See NOA 01-0718.09

F. OTHER

See NOA 01-0718.09.

2. EVIDENCE SUBMITTED UNDER PREVIOUS APPROVAL # 04-0621.01

A. DRAWINGS

1. *None.*

B. TESTS

1. *None.*

C. CALCULATIONS

1. *None.*

D. QUALITY ASSURANCE

1. *By Miami-Dade County Building Code Compliance Office.*

E. MATERIAL CERTIFICATIONS

1. *None.*

F. OTHER

1. *NOA # 02-0312.08 cover page states the number of sheets incorrectly "sheets 1 through 18". This NOA #04-0621.01 is issued to revise NOA # 02-0312.08 and correct the number of sheets on the cover page to " sheets 1 through 7 of 7". This is the only change. This file is authorized by Mr. Ted Berman, P.E. with no fee.*

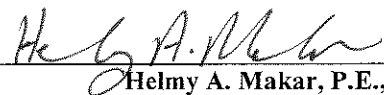

Helmy A. Makar, P.E., M.S.
Product Control Section Supervisor

NOA No. 17-0925.04

Expiration Date: 10/22/2022

Approval Date: 10/19/2017

NOTICE OF ACCEPTANCE: EVIDENCE SUBMITTED

- 3. EVIDENCE SUBMITTED UNDER PREVIOUS APPROVAL # 06-0117.05**
- A. DRAWINGS**
1. *Drawing No. 98002, titled "0.050" Maximum Impact Storm Panel", sheets 1 through 7 of 7, prepared by Ramms Engineering, Inc., dated January 10, 1998, last revision dated 01/12/2006, signed & sealed by Robert Monsour, P.E., on 01/12/06.*
- B. TESTS**
1. *None.*
- C. CALCULATIONS**
1. *Anchor analyses dated January 06, 2006, 41 pages, prepared by Ramms Engineering, Inc., signed & sealed on January 06, 2006 by Robert Monsour, P.E.*
- D. QUALITY ASSURANCE**
1. *By Miami-Dade County Building Code Compliance Office.*
- E. MATERIAL CERTIFICATIONS**
1. *None.*
- 4. EVIDENCE SUBMITTED UNDER PREVIOUS APPROVAL # 11-0831.04**
- A. DRAWINGS**
1. *None.*
- B. TESTS**
1. *None.*
- C. CALCULATIONS**
1. *None.*
- D. QUALITY ASSURANCE**
1. *By Miami-Dade County Building and Neighborhood Compliance Department.*
- E. MATERIAL CERTIFICATIONS**
1. *None.*
- F. OTHERS**
1. *Letter of compliance with the Florida Building Code, 2007 Edition, issued by Ramms Engineering, Inc., dated August 22, 2011, signed and sealed by Robert S. Mansour, P.E.*

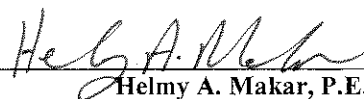

Helmy A. Makar, P.E., M.S.
Product Control Section Supervisor
NOA No. 17-0925.04
Expiration Date: 10/22/2022
Approval Date: 10/19/2017

Shutter Tech, Inc.

NOTICE OF ACCEPTANCE: EVIDENCE SUBMITTED

- 5. EVIDENCE SUBMITTED UNDER PREVIOUS APPROVAL #12-0628.12**
- A. DRAWINGS**
1. *None.*
- B. TESTS**
1. *Test report on Large Missile Impact Test, Cyclic Wind Pressure Test and Uniform Static Air Pressure Test of 0.050 Aluminum Storm Panel Shutter, prepared by Blackwater Testing, Inc., Report No. BT-12-002, dated May 30, 2012, signed and sealed by Yamil G. Kuri, P.E.*
- C. CALCULATIONS**
1. *None.*
- D. QUALITY ASSURANCE**
1. *By Miami-Dade County Department of Regulatory and Economic Resources.*
- E. MATERIAL CERTIFICATIONS**
1. *None.*
- F. OTHERS**
1. *Letter of compliance with the Florida Building Code, 2010 Edition, issued by Ramms Engineering, Inc., dated June 26, 2012, signed and sealed by Robert S. Mansour, P.E.*
- 6. EVIDENCE SUBMITTED UNDER PREVIOUS APPROVAL #14-0127.03**
- A. DRAWINGS**
1. *Drawing No. 98002, titled "Maximum Impact .050 Aluminum Storm Panel", sheets 1 through 7 of 7, prepared by Ramms Engineering, Inc., dated January 10, 1998, last revision dated January 01, 2014, signed & sealed by Robert Monsour, P.E.*
- B. TESTS**
1. *None.*
- C. CALCULATIONS**
1. *None.*
- D. QUALITY ASSURANCE**
1. *By Miami-Dade County Department of Regulatory and Economic Resources.*
- E. MATERIAL CERTIFICATIONS**
1. *None.*
- F. OTHERS**
1. *Asset Purchase Agreement.*

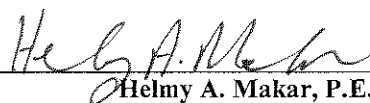

Helmy A. Makar, P.E., M.S.
Product Control Section Supervisor
NOA No. 17-0925.04
Expiration Date: 10/22/2022
Approval Date: 10/19/2017

Shutter Tech, Inc.

NOTICE OF ACCEPTANCE: EVIDENCE SUBMITTED

- 7. EVIDENCE SUBMITTED UNDER PREVIOUS APPROVAL #15-0714.22**
- A. DRAWINGS**
1. *Drawing No. 98002, titled "Maximum Impact .050 Aluminum Storm Panel", sheets 1 through 7 of 7, prepared by Ramms Engineering, Inc., dated January 10, 1998, last revision dated September 29, 2015, signed & sealed by Robert Monsour, P.E.*
- B. TESTS**
1. *None.*
- C. CALCULATIONS**
1. *None.*
- D. QUALITY ASSURANCE**
1. *By Miami-Dade County Department of Regulatory and Economic Resources.*
- E. MATERIAL CERTIFICATIONS**
1. *None.*
- F. OTHERS**
1. *FBC, 2014 Edition compliance letter prepared by Ramms Engineering, Inc., dated June 26, 2015, signed & sealed by Robert Monsour, P.E.*
- 8. NEW EVIDENCE SUBMITTED**
- A. DRAWINGS**
1. *Drawing No. 98002, titled "Maximum Impact .050 Aluminum Storm Panel", sheets 1 through 7 of 7, prepared by Ramms Engineering, Inc., dated January 10, 1998, last revision dated July 14, 2017, signed & sealed by Robert Monsour, P.E.*
- B. TESTS**
1. *None.*
- C. CALCULATIONS**
1. *None.*
- D. QUALITY ASSURANCE**
1. *By Miami-Dade County Department of Regulatory and Economic Resources.*
- E. MATERIAL CERTIFICATIONS**
1. *None.*
- F. OTHERS**
1. *FBC, 2014 Edition and 2017 Edition compliance letter prepared by Ramms Engineering, Inc., dated July 18, 2017, signed & sealed by Robert Monsour, P.E.*

Helmy A. Makar, P.E., M.S.
Product Control Section Supervisor
NOA No. 17-0925.04
Expiration Date: 10/22/2022
Approval Date: 10/19/2017

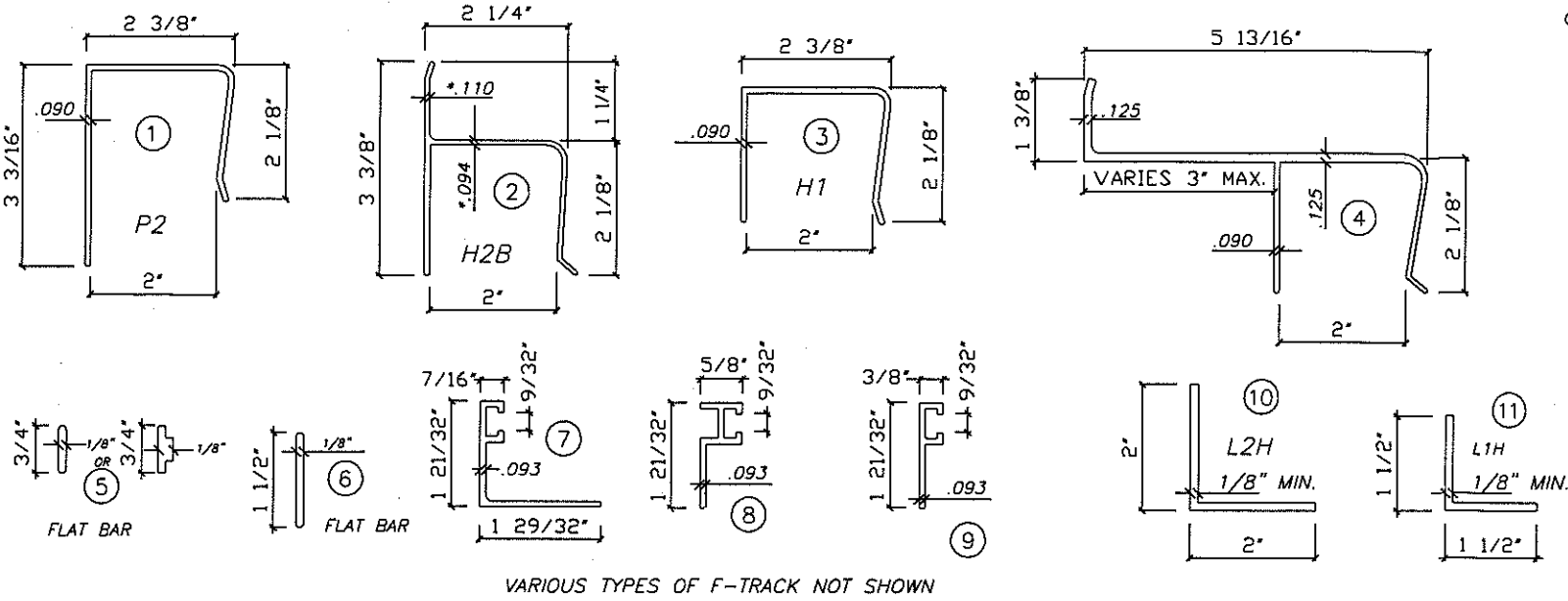

VARIOUS TYPES OF F-TRACK NOT SHOWN

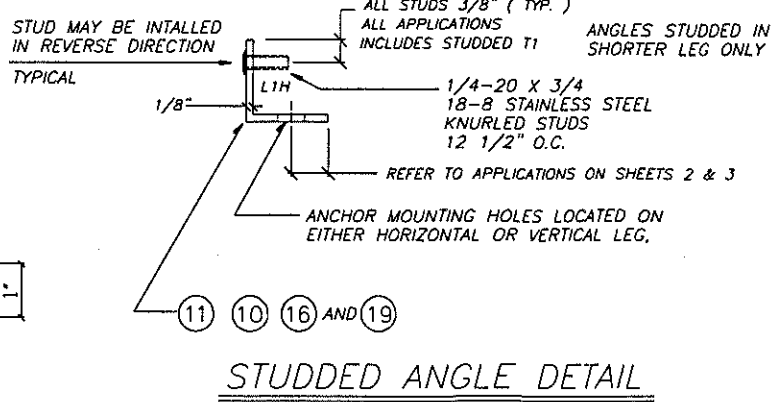
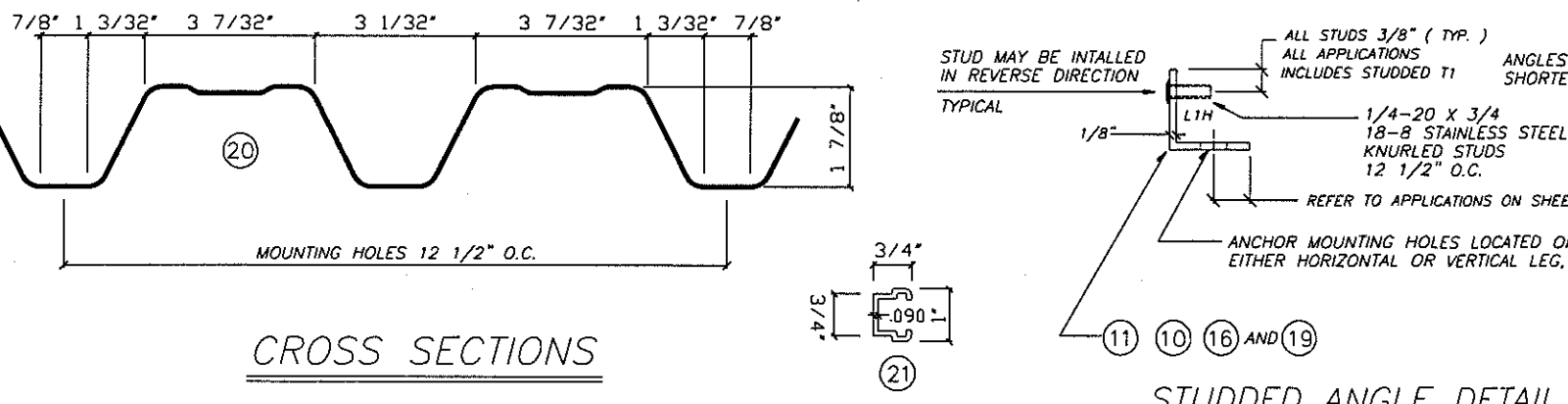
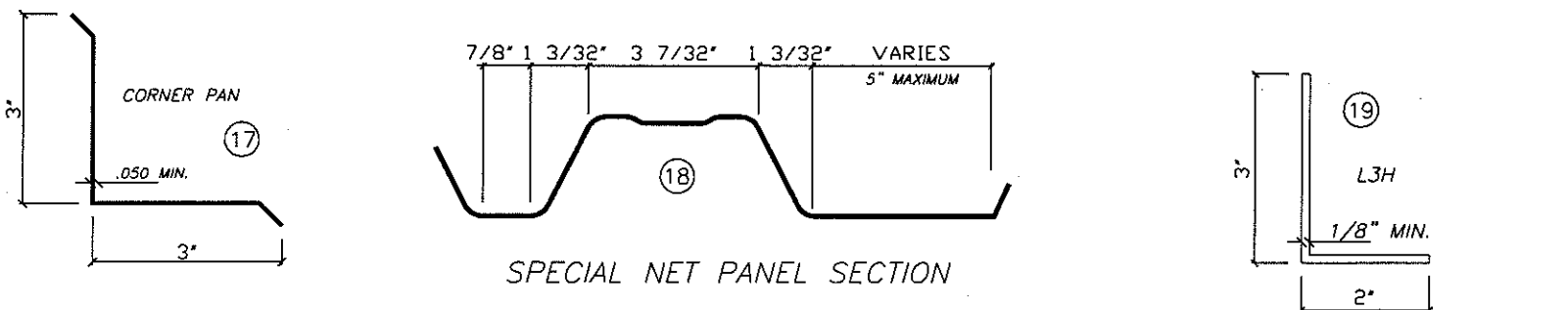
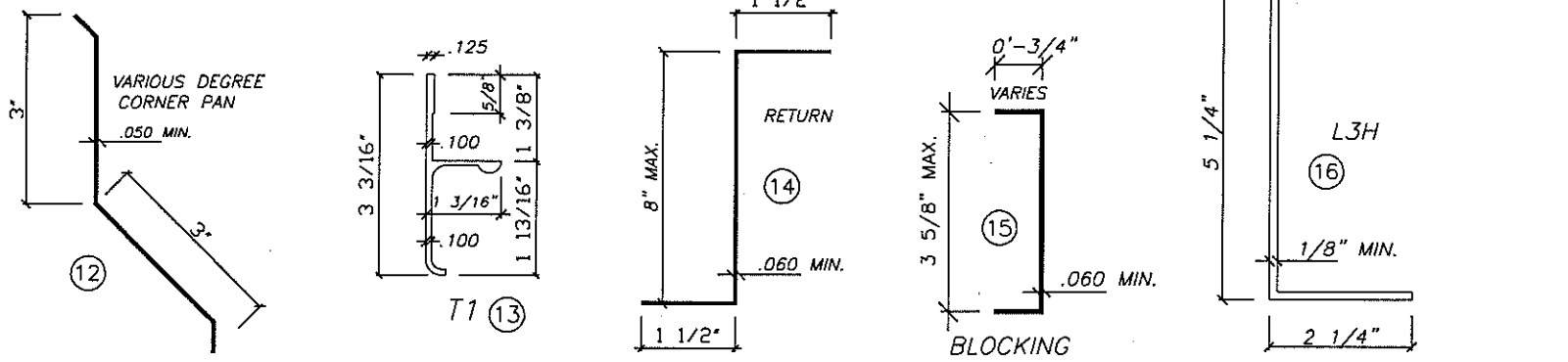

1/8" x 1 1/2" FLAT STUDDED STRAP MAY BE USED IN PLACE OF ANGLE

COMPLIES WITH:
FLORIDA BUILDING CODE SIXTH EDITION (2017) (H.V.H.Z.)
TESTED TO TA201, TA202 AND TA203

**.050 ALUM.
(H.V.H.Z.)**

DESIGN CRITERIA:
WIND LOADS TO BE CALCULATED AS PER ASCE 7-10
NO INCREASE IN ALLOWABLE STRESS WAS USED IN THE DESIGN OF THIS PRODUCT

GENERAL NOTES:
ALL ALUMINUM EXTRUSIONS TO BE ALLOY 6063-T6 OR EQUAL

STORM PANELS SHALL BE:
.050 5052 H-32 ALUMINUM OR EQUAL
SMOOTH OR EMBOSSED WITH A NOMINAL WIDTH OF 12 1/2"

THE STORM PANEL SHUTTER MAY BE INSTALLED VERTICALLY OR HORIZONTALLY, IN ACCORDANCE TO THE DETAILED SPECIFICATIONS HEREIN.

PANELS MAY BE NOTCHED OR MITERED TO ACCOMMODATE AN OBSTRUCTION

ANCHORAGE OF THE SHUTTER SYSTEM TO CONCRETE OR MASONRY SHALL CONSIST OF THE FOLLOWING OR EQUAL WITH MINIMUM ULTIMATE LOAD VALUES SHOWN

1/4" DIA. RAWL LOK/BOLT ANCHOR (SLEEVED DRIVE ANCHOR)
MIN. TENSILE 1190 - MIN. SHEAR 1520 - 1 1/8" MIN. EMBED. IN CONCRETE
MIN. TENSILE 1200 - MIN. SHEAR 1270 - 1 1/8" MIN. EMBED. IN MASONRY

1/4-20 RAWL CALK-IN ANCHOR (MACHINE SCREW ANCHOR) WITH 1/4-20 BOLTS
MIN. TENSILE 1870 - MIN. SHEAR 1730 - 7/8" MIN. EMBED. IN CONCRETE
MIN. TENSILE 880 - MIN. SHEAR 1340 - 7/8" MIN. EMBED. IN MASONRY

1/4" PERMA-SEAL TAPPER BY RAWL (MASONRY SCREWS VARIOUS HEAD TYPES)
MIN. TENSILE 1520 - MIN. SHEAR 1980 - 1 1/2" MIN. EMBED. IN CONCRETE
MIN. TENSILE 880 - MIN. SHEAR 1270 - 1 1/4" MIN. EMBED. IN MASONRY

1/4" ZAMAC NAILIN BY RAWL (ZAMAC HAMMER DRIVES)
MIN. TENSILE 980 - MIN. SHEAR 1400 - 1 3/8" MIN. EMBED. IN CONCRETE
MIN. TENSILE 730 - MIN. SHEAR 1320 - 1 1/4" MIN. EMBED. IN MASONRY

ANCHORAGE TO WOOD CONSTRUCTION SHALL BE 1/4" STEEL LAGS OR LARGER WITH 1" MIN. THREAD PENETRATION, 1/4-20 BRASS WOOD BUSHINGS OR 1/4" ELCO PANEL MATES WITH 1 7/8" MIN. THREAD PENETRATION.

REFER TO SHEETS 5,6 & 7 OF 7 FOR ANCHOR SPACING AND MINIMUM EMBEDMENTS

IT SHALL BE THE RESPONSIBILITY OF THE CONTRACTOR TO VERIFY THE SOUNDNESS OF THE STRUCTURE TO WITHSTAND THE ADDITIONAL LOADS AND INSURE PROPER ANCHORAGE.

EACH PANEL SHALL BEAR A PERMANENT LABEL OR STAMP SHOWING " SHUTTER TECH, INC. HIALEAH, FL " " DADE COUNTY PRODUCT CONTROL APPROVED "

WARNING TO OWNER OR TENANT LOCATED IN EACH HEADER OR ONE PANEL OF EACH OPENING, STATING " STORM PANELS WILL NOT OFFER HURRICANE PROTECTION UNLESS ALL REINFORCING STRAPS OR BOLTS ARE PROPERLY INSTALLED, WHEN REQUIRED "

PERMANENT FASTENER COMPONENTS, EMBEDDED ANCHOR BOLTS, THREADED CONES OR METAL SHIELDS, NOT IN USE, MUST BE PROTECTED AGAINST CORROSION, CONTAMINATION AND DAMAGE AT ALL TIME.

PRODUCT REVISED as complying with the Florida Building Code
Acceptance No 17-0925.04
Expiration Date 10/22/2022
By: [Signature]
Miami Dade Product Control

[Handwritten signature]

ROBERT S. MONSOUR, PE
EB-0006024
RAMMS ENGINEERING, INC.

BUILDING CODE COMPLIANCE

REVISIONS	BY
09/11/98	SP
01/06/06	SP
01/16/14	SP
09/29/15	SP
07/14/17	SP

RAMMS ENGINEERING, INC.
Structural Design
2100 W. 76th STREET, SUITE 311
HIALEAH, FLORIDA 33016
EB 0006024

MAXIMUM IMPACT .050 ALUMINUM STORM PANEL
SHUTTER-TECH, INC.
7485 W. SECOND CT. HIALEAH, FL 33014

DATE	SCALE	JOB	SHEET
SEP/JRB/RSM	01/10/98	98002	1
APPROVED	SHOWN		

7 SHEETS

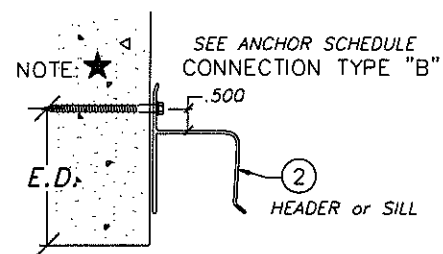

DETAIL 1

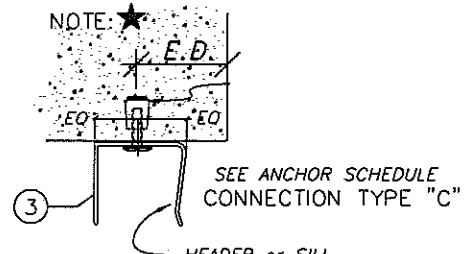

DETAIL 2

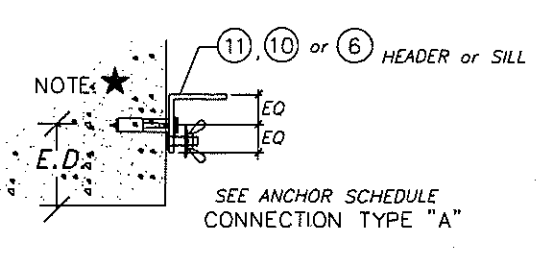

DETAIL 3

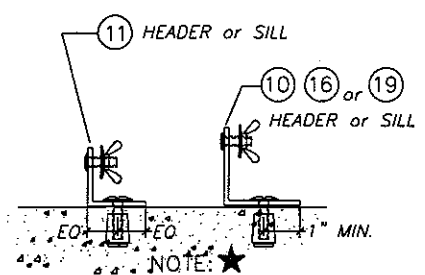

DETAIL 4

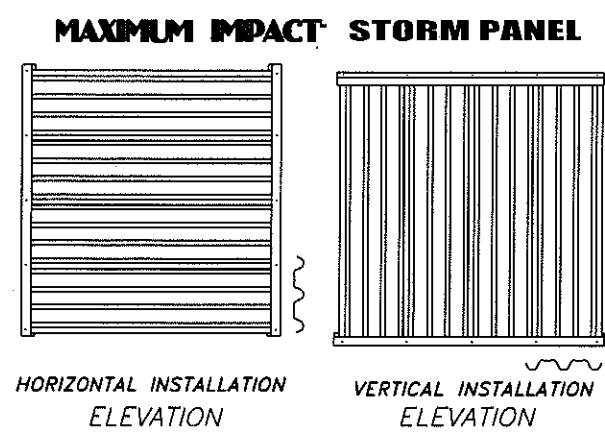

HORIZONTAL INSTALLATION ELEVATION

VERTICAL INSTALLATION ELEVATION

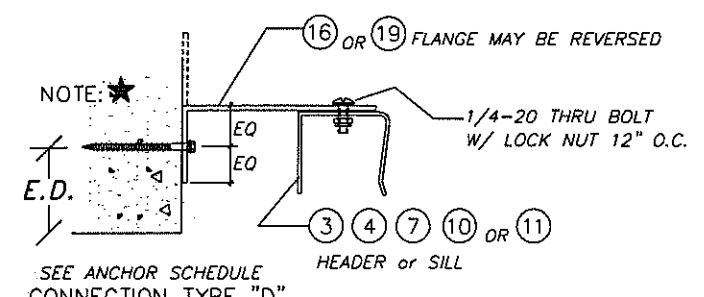

DETAIL 5

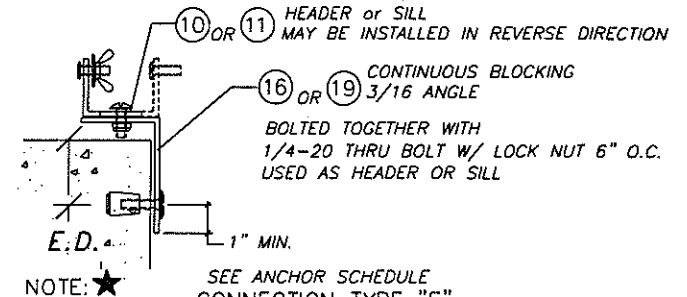

DETAIL 6

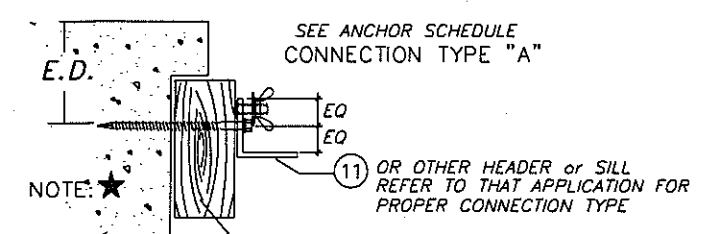

DETAIL 7

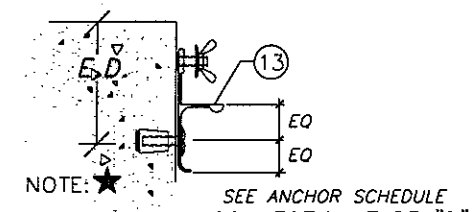

DETAIL 8

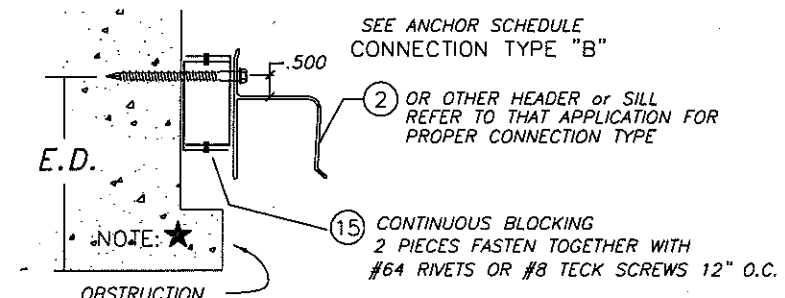

DETAIL 9

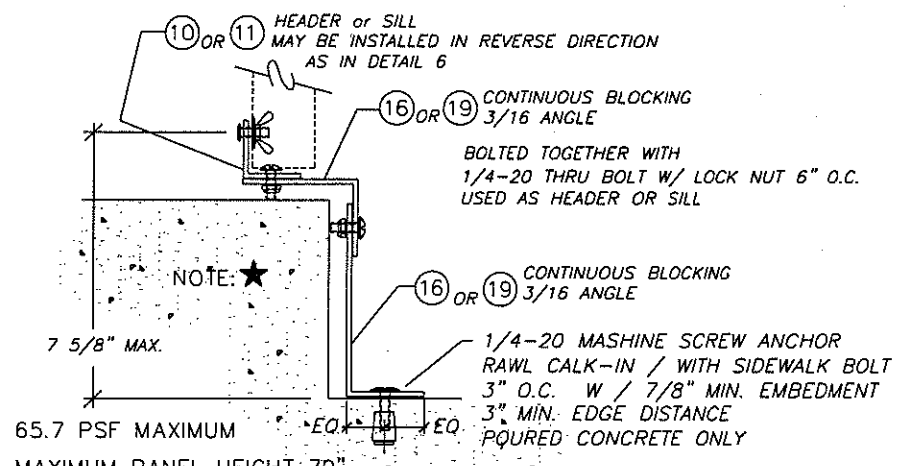

DETAIL 10

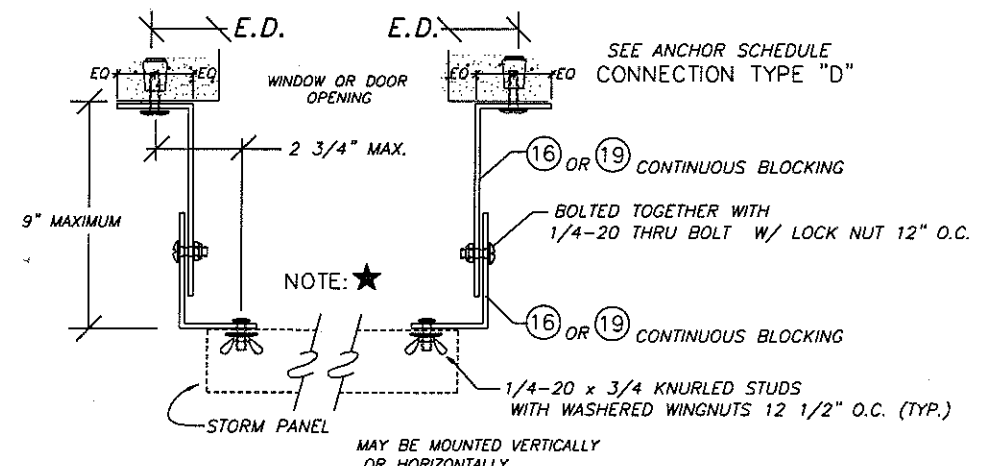

DETAIL 11

NOTE: ★

IT SHALL BE THE RESPONSIBILITY OF THE CONTRACTOR TO VERIFY THE SOUNDNESS OF THE STRUCTURE TO WITH STAND THE ADDITIONAL LOADS AND INSURE PROPER ANCHORAGE. SHUTTER SYSTEM MAY BE INTSALL INTO WOOD, CONCRETE, MASONRY.

WHEN ANCHORING TO WOOD, THE WOOD MUST BE A MINIMUM 2 X 4 EQUAL TO #2 SOUTHERN PINE WITH 0.55 SPECIFIC GRAVITY AND STRUCTURALLY PART OF THE FRAMING STRUCTURE OR SUCURELY ATTACHED TO FRAMING STRUCTURE

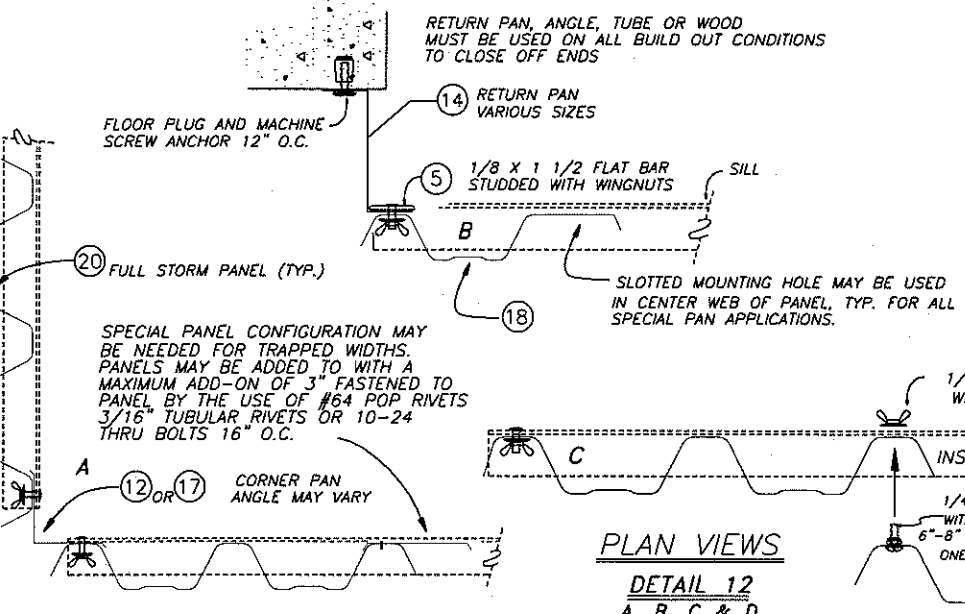

PLAN VIEWS
DETAIL 12
A, B, C & D

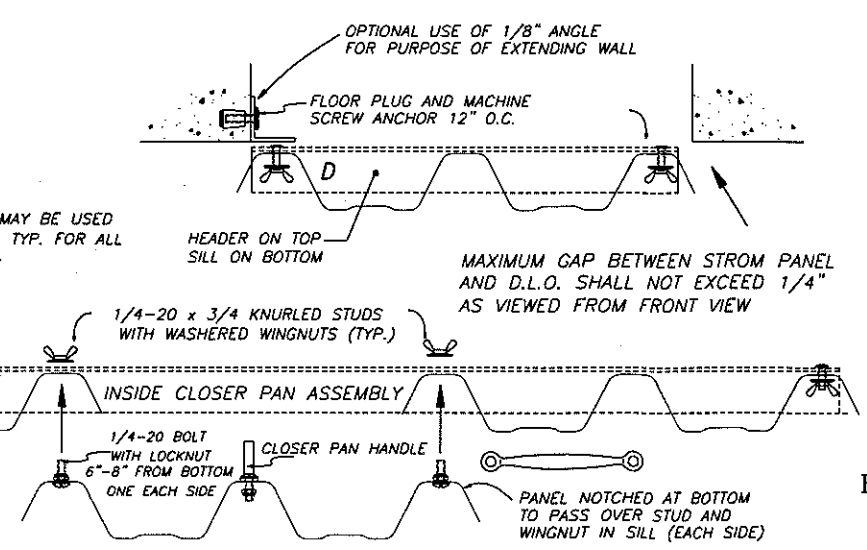

ROBERT S. MONSOUR, PE
EB-0006024
RAMMS ENGINEERING, INC.

PRODUCT REVISED
as complying with the Florida
Building Code
Acceptance No 17-0925.04
Expiration Date 10/22/2022
By *Heba M...*
Miami Date Product Control

Monsour

BUILDING CODE COMPLIANCE

REVISIONS	BY
09/11/98	SP
01/12/06	SP
01/16/14	SP

RAMMS ENGINEERING, INC.
Structural Design
2100 W. 76th STREET, SUITE 311
HIALEAH, FLORIDA 33016

MAXIMUM IMPACT .050 ALUMINUM STORM PANEL

SHUTTER-TECH, INC.
7485 W. SECOND CT. HIALEAH, FL 33014

DATE	BY	SCALE	JOB	SHEET
SEP / JRB / RSM				
01/10/98				
SHOWN				
98002				
2				
7				

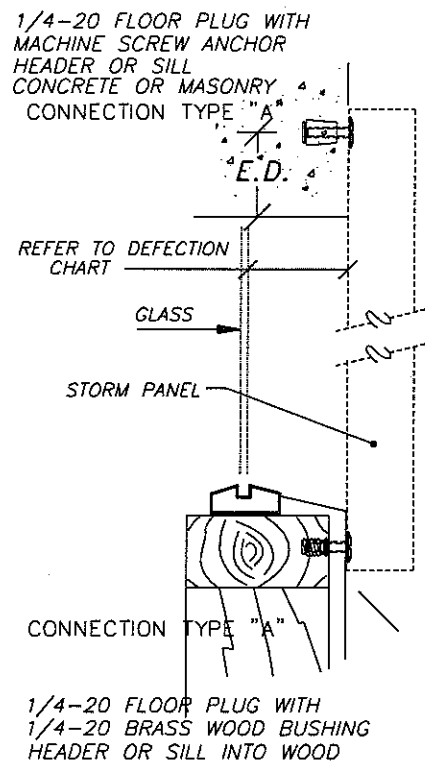

NOTE:
THE METALTECH STORM PANEL MAY BE INSTALLED WITHOUT THE USE OF AN EXTRUDED HEADER OR SILL. THE SHUTTER MAY BE ANCHORED DIRECTLY TO THE STRUCTURE WITH THE USE OF ONE OR A COMBINATION OF DETAIL 13

NOTE:★

DETAIL 13

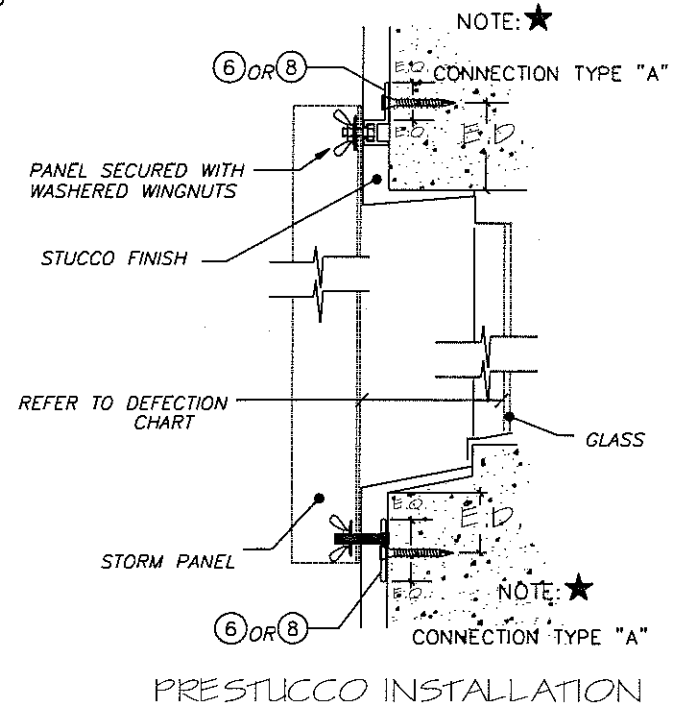
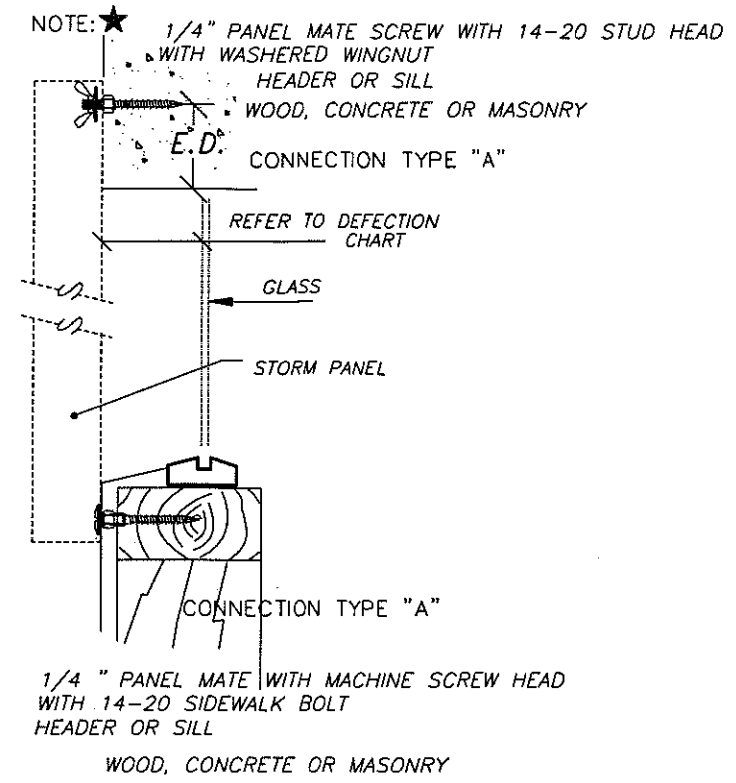

DETAIL 14

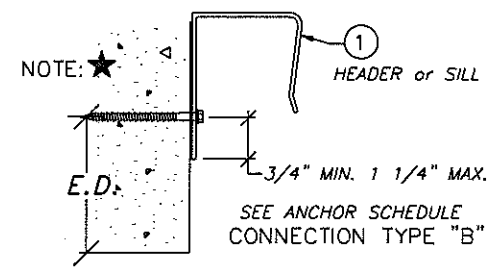

DETAIL 15

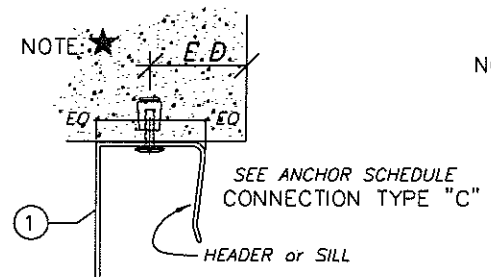

DETAIL 16

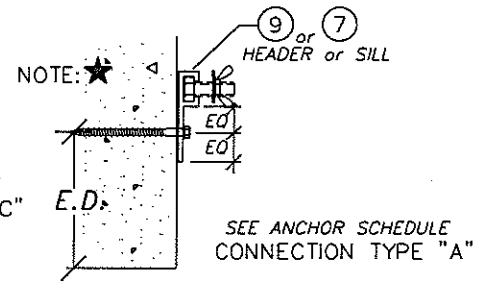

DETAIL 17

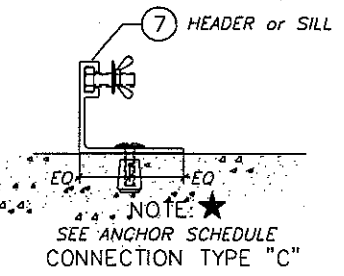

DETAIL 18

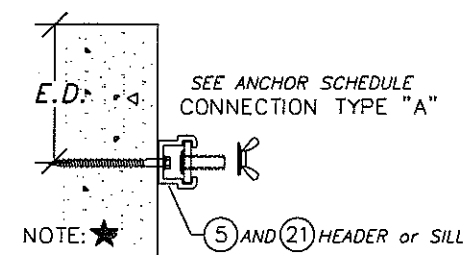

DETAIL 19

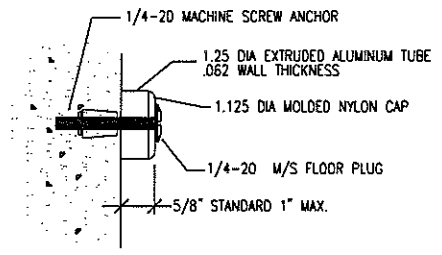

DETAIL 20

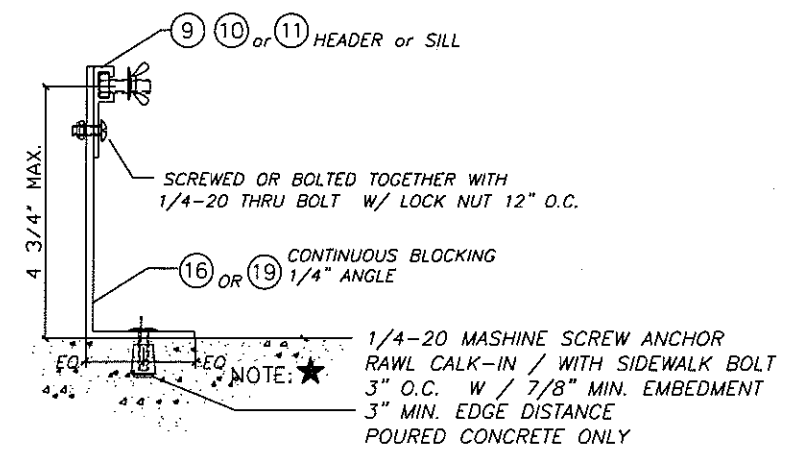

59.5 PSF MAXIMUM / PANEL HEIGHT 109\"/>

DETAIL 21
ADJUSTABLE HEADER OR SILL

NOTE:★
IT SHALL BE THE RESPONSIBILITY OF THE CONTRACTOR TO VERIFY THE SOUNDNESS OF THE STRUCTURE TO WITH STAND THE ADDITIONAL LOADS AND INSURE PROPER ANCHORAGE. SHUTTER SYSTEM MAY BE INTSALL INTO WOOD, CONCRETE, MASONRY.
WHEN ANCHORING TO WOOD, THE WOOD MUST BE A MINIMUM 2 X 4 EQUAL TO #2 SOUTHERN PINE WITH 0.55 SPECIFIC GRAVITY AND STRUCTURALLY PART OF THE FRAMING STRUCTURE OR SUCURELY ATTACHED TO FRAMING STRUCTURE

PRODUCT REVISED as complying with the Florida Building Code
Acceptance No 17-0925.04
Expiration Date 10/23/2022
By *Heba*
Miami Dept Product Control

ROBERT S. MONSOUR, PE
EB-0006024
RAMMS ENGINEERING, INC.

BUILDING CODE COMPLIANCE

REVISIONS	BY
09/11/98	SP
01/12/06	SP
01/16/14	SP

MAXIMUM IMPACT STORM PANEL

RAMMS ENGINEERING, INC.
Structural Design
2100 W. 76th STREET, SUITE 311
HALEAH, FLORIDA 33016

MAXIMUM IMPACT .050 ALUMINUM STORM PANEL
SHUTTER-TECH, INC.
7485 W. SECOND CT. HIALEAH, FL 33014

DATE	APPROVED
SEP / JRB / RSM	
DATE: 01/10/97	
SCALE: SHOWN	
JOB: 98002	
SHEET: 3	
7	

THE SHUTTER TECH STORM PANELS MAY BE INSTALLED WITH OR WITHOUT THE HORIZONTAL BRACE STRAP. REFER TO PANEL DEFLECTION CHARTS.

.050 ALUMINUM MAXIMUM IMPACT STORM PANEL

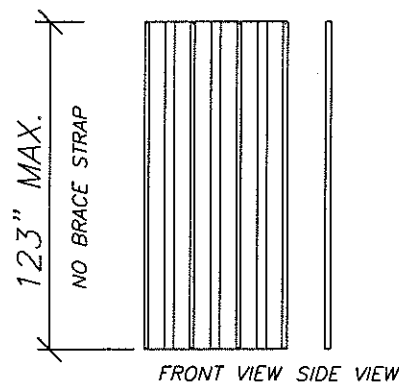

**123" MAX. PANEL HEIGHT
NO PANEL STRAP
IS REQUIRED**

PANEL DEFLECTION CHART
WITHOUT HORIZONTAL STRAP

PANEL HEIGHT	0"-68"	over 68"-96"	over 96"-123"
WALL MOUNT	2 5/8"	3 5/8"	4"
INSIDE MOUNT	2 5/8"	3 5/8"	4"
BUILD OUT	2 5/8"	3 5/8"	4"

MINIMUM DISTANCE BETWEEN GLASS AND PANEL

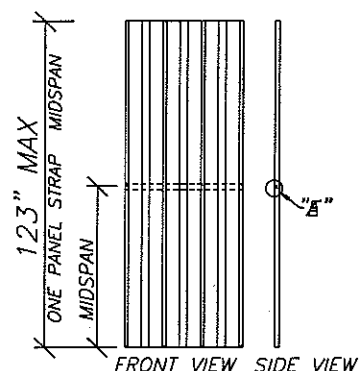

**123" MAX. PANEL HEIGHT
ONE PANEL STRAP
LOCATED MIDSPAN**

PANEL DEFLECTION CHART
WITH HORIZONTAL STRAP

PANEL HEIGHT	0"-107"	over 107"-123"
WALL MOUNT	2 13/16"	3 3/16"
INSIDE MOUNT	2 13/16"	3 3/16"
BUILD OUT	2 13/16"	3 3/16"

MINIMUM DISTANCE BETWEEN GLASS AND PANEL

.050 ALUM

DESIGN PRESSURE	PANEL SPAN
44.40	123"
47.81	120"
51.23	117"
58.06	112"
61.47	110"
66.85	106"
71.46	102"
75.30	97"
81.45	90"
86.83	84"
91.44	80"

HORIZONTAL BRACE STRAP

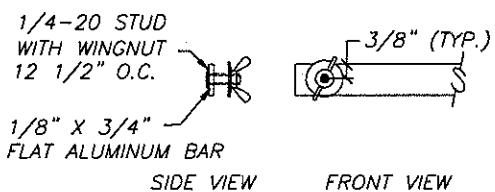

DETAIL "E"

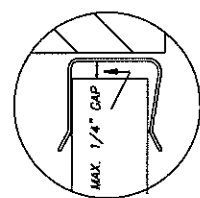

MAXIMUM GAP BETWEEN PANEL AND HEADER IS 1/4" (TYP.)

DETAIL "F"

DETAIL 13 ON SHEET 3

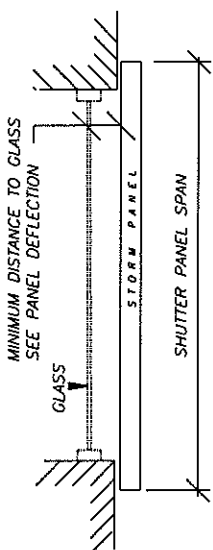

DETAIL 13 ON SHEET 3

DETAIL 3,4, & 8 ON SHEET 2

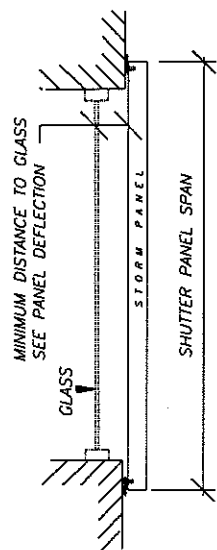

DETAIL 3,4, & 8 ON SHEET 2

DETAIL 1 ON SHEET 2
DETAIL 15 ON SHEET 3

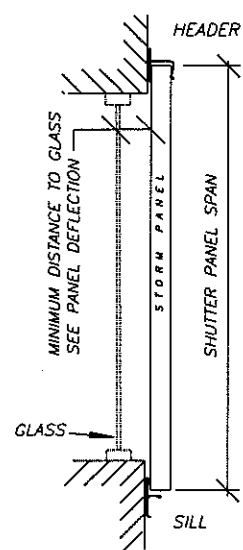

DETAILS 3,4 AND 8 ON SHEET 2

DETAILS 5,7,9,10 AND 11 ON SHEET 2

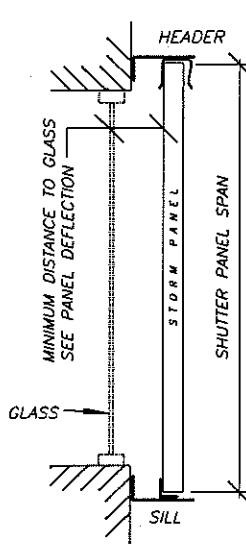

DETAILS 5,7,9,10 AND 11 ON SHEET 2

DETAIL 2 ON SHEET 2
DETAIL 16 ON SHEET 3

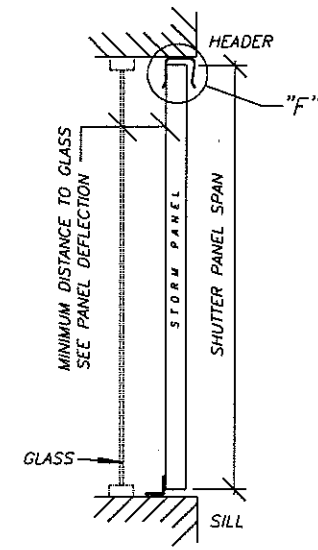

DETAIL 4 ON SHEET 2

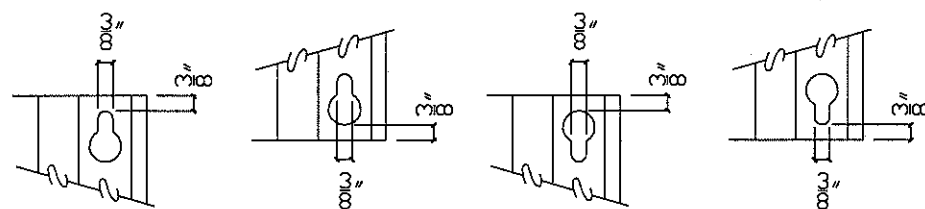

WALL MOUNT

ANCHORING PANEL TOP & BOTTOM NO HDR. OR SILL

WALL MOUNT

ANCHORING PANEL TOP & BOTTOM WITH STUDDED HDR/SILL

WALL MOUNT

WITH HDR. AND SILL

BUILD OUT

WITH HDR. AND SILL

INSIDE MOUNT

WITH HDR. AND SILL

TYPICAL SECTION VIEWS

FASTENER MUST BE IN NARROW PORTION OF KEY HOLE MOUNTING HOLE MAY ALSO BE A 9/16" DIA. CIRCLE

DETAIL "G"

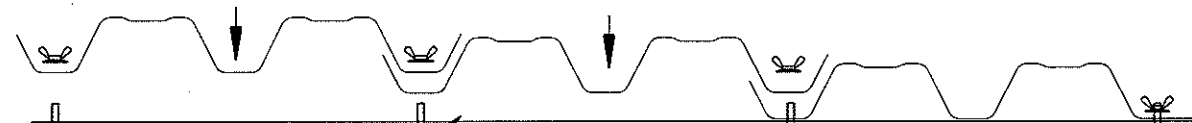

HORIZONTAL BRACE STRAP
HEADER AND SILL

PANELS MAY RUN CONTINUOUS BY WIDTH EITHER HORIZONTALLY OR VERTICALLY

EXPLODED ASSEMBLY

ROBERT S. MONSOUR, PE
EB-0006024
RAMS ENGINEERING, INC.

PRODUCT REVISED
as complying with the Florida
Building Code
Acceptance No 17-0925.04
Expiration Date 10/22/2022
By *Hesha A. Alor*
Miami Data Product Control

BUILDING CODE COMPLIANCE



REVISIONS	BY
09/11/98	SP
01/16/14	SP

RAMS ENGINEERING, INC.
Structural Design
2100 W. 76th STREET, SUITE 311
HIALEAH, FLORIDA 33016
EB 0006024

MAXIMUM IMPACT .050 ALUMINUM STORM PANEL
SHUTTER-TECH, INC.
7485 W. SECOND CT. HIALEAH, FL 33014

DATE	APPROVED
SEP/JRB	
DATE: 01/10/98	
SCALE: SHOWN	
JOB: 98002	
SHEET: 4	
7	

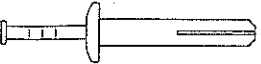
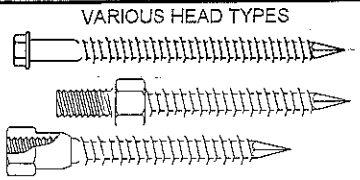
ANCHOR SCHEDULE

ANCHOR SPACING vs DESIGN PRESSURE AND CONNECTION TYPE			UP TO 59.6 PSF										UPTO 71.5 PSF									
			POURED CONCRETE					CONCRETE BLOCK					POURED CONCRETE					CONCRETE BLOCK				
			CONNECTION TYPE					CONNECTION TYPE					CONNECTION TYPE					CONNECTION TYPE				
ANCHOR TYPE	PANEL	E.D.	A	B	C	D	E	A	B	C	D	E	A	B	C	D	E	A	B	C	D	E
 1/4" RAWL LOK/BOLT (SLEEVE ANCHOR) 1 1/8" MIN. EMBEDMENT	68" SPAN	3"	16	13	8	13	13	16	13	10	13	13	16	13	7	13	13	16	13	8	13	13
		2"	16	13	7	13	13	16	13	8	13	13	16	13	5	13	13	16	13	6	13	13
		1 1/4"	16	13	5	13	13	16	13	6	13	13	14	13	4	13	13	14	13	4	13	13
	88" SPAN	3"	16	13	6	13	13	16	13	7	13	13	14	6	5	9	10	14	6	6	9	10
		2"	15	11	5	13	13	15	11	6	13	13	12	6	4	8	9	12	6	5	8	9
		1 1/4"	13	10	4	13	13	13	10	5	13	13	11	5	3	7	8	11	5	4	7	8
	105" span	3"	14	6	5	9	10	14	7	6	9	10	11	4	4	5	4	12	4	5	5	4
		2"	12	6	4	8	9	12	6	5	8	9	10	4	4	5	4	10	4	4	5	4
		1 1/4"	11	5	3	7	8	11	5	4	7	8	9	3	3	4		9	3	3	4	
	123" span	3"	11	4	4	5	4	12	4	5	5	4										
		2"	10	4	4	5	4	10	4	4	5	4										
		1 1/4"	9	3	3	4	3	9	3	3	4	3										
 1/4" RAWL ZAMAC NAILIN DRIVE (HAMMER DRIVE) 1 3/8" MIN. EMBEDMENT IN CONCRETE 1 1/4" MIN. EMBEDMENT IN BLOCK	68" SPAN	3"	16	13	7	13	13	13	13	6	13	13	15	13	6	13	13	11	11	5	11	11
		2"	15	13	6	13	13	12	12	5	12	12	13	13	5	13	13	10	10	4	10	10
		1 1/4"	14	13	5	13	13	10	10	4	10	10	12	12	4	12	12	9	9	3	9	9
	88" SPAN	3"	13	10	6	13	13	10	8	5	10	10	11	5	5	7	8	8	4	4	5	6
		2"	12	9	5	12	12	9	7	4	9	9	10	5	4	6	7	7	3	3	5	5
		1 1/4"	11	8	4	11	11	8	6	3	8	8	9	4	3	6	6	7	3	3	4	5
	105" span	3"	11	5	5	7	8	8	4	4	5	6	9	3	4	4	3	7		3	3	3
		2"	10	5	4	7	7	7	4	3	5	6	8	3	3	4	3	6		3	3	
		1 1/4"	9	4	3	6	7	7	3	3	4	5	8	3	3	4	3	6		3	3	
	123" span	3"	9	3	4	4	3	7		3	3	3										
		2"	8	3	3	4	3	6		3	3											
		1 1/4"	8	3	3	4	3	6		3	3											
 (MASONRY SCREWS) 1/4" RAWL PERMA-SEAL TAPPER 1/4" ELCO PANEL MATES 1 1/2" MIN. EMBEDMENT IN CONCRETE 1 1/4" MIN. EMBEDMENT IN BLOCK	68" SPAN	3"	16	13	11	13	13	16	13	7	13	13	16	13	9	13	13	13	13	6	13	13
		2"	16	13	9	13	13	14	13	6	13	13	16	13	8	13	13	12	12	5	12	12
		1 1/4"	16	13	8	13	13	13	13	5	13	13	16	13	6	13	13	10	10	4	10	10
	88" SPAN	3"	16	13	9	13	13	12	9	5	12	12	16	8	7	11	12	10	5	4	6	7
		2"	16	13	7	13	13	11	8	4	11	11	15	7	6	10	11	9	4	4	6	6
		1 1/4"	16	13	6	13	13	10	7	4	10	10	14	7	5	9	10	8	4	3	5	6
	105" span	3"	16	8	7	11	13	10	5	4	7	8	15	5	6	7	5	8	3	4	4	3
		2"	16	7	6	10	12	9	4	4	6	7	13	5	5	6	5	8	3	3	4	3
		1 1/4"	14	7	5	9	10	8	4	3	5	6	12	4	4	5	4	7		3	3	
	123" span	3"	15	5	6	7	5	8	3	4	4	3										
		2"	13	5	5	6	5	8	3	3	4	3										
		1 1/4"	12	4	4	5	4	7		3	3											
 1/4-20 x 7/8", 1/2" DIA. RAWL CALK-IN (MACHINE SCREW ANCHOR) 7/8" MIN. EMBEDMENT	68" SPAN	3"	16	13	12	13	13	16	13	7	13	13	16	13	10	13	13	13	13	6	13	13
		2.5"	16	13	10	13	13	14	13	6	13	13	16	13	9	13	13	12	12	5	12	12
		2"	16	13	8	13	13	13	13	5	13	13	16	13	7	13	13	10	10	4	10	10
	88" SPAN	3"	16	13	9	13	13	12	9	5	12	12	16	10	8	13	13	10	5	4	6	7
		2.5"	16	13	8	13	13	11	8	5	11	11	16	9	7	12	13	9	4	4	6	6
		2"	16	13	6	13	13	10	7	4	10	10	16	8	5	11	12	8	4	3	5	6
	105" span	3"	16	10	8	13	13	10	5	4	7	8	16	6	7	8	3	8	3	4	4	3
		2.5"	16	9	7	13	13	9	4	4	6	7	16	6	6	8	3	8	3	3	4	3
		2"	16	8	5	11	13	8	4	3	5	6	14	5	4	7	3	7		3	3	3
	123" span	3"	16	6	7	8	7	8	3	4	4	3										
		2.5"	16	6	6	8	6	8	3	3	4	3										
		2"	14	5	4	7	5	7		3	3	3										

NOTES:

SPANS AND LOADS SHOWN IN THIS SCHEDULE ARE FOR DETERMINING ANCHOR SPACING ONLY. FOR ALLOWABLE SPANS VS. DESIGN LOADS REFER TO SHEET 4.

MINIMUM ENBEDMENT AND EDGE DISTANCE EXCLUDES STUCCO AND/OR WALL FINISHES.

SHADED AREAS REPRESENT ANCHOR CONDITIONS THAT ARE NOT ACCEPTABLE.

IT SHALL BE THE RESPONSIBILITY OF THE CONTRACTOR TO VERIFY THE SOUNDNESS OF THE STRUCTURE TO WITH STAND THE ADDITIONAL LOADS AND INSURE PROPER ANCHORAGE. SHUTTER SYSTEM MAY BE INTSALL INTO WOOD, CONCRETE OR MASONRY.

REVISIONS	BY
09/11/98	SP
01/06/06	SP
01/16/14	SP

RAMMS ENGINEERING, INC.
Structural Design

2100 W. 76th STREET, SUITE 311
HIALEAH, FLORIDA 33016

EB 0006024

MAXIMUM IMPACT .050 ALUMINUM STORM PANEL

SHUTTER-TECH, INC.

7485 W. SECOND CT. HIALEAH, FL 33014

DRAWN
SEP/JRB

APPROVED

DATE
01/10/98

SCALE
SHOWN

JOB
98002

SHEET
5

7

PRODUCT REVISED
as complying with the Florida
Building Code
Acceptance No 17-0925.04
Expiration Date 10/22/2022



By *H. A. M.*
Miami Design Product Control

ROBERT S. MONSOUR, PE
EB-0006024
RAMMS ENGINEERING, INC.

BUILDING CODE COMPLIANCE

Monsour
9/1/17

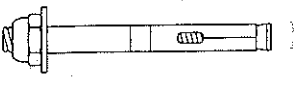
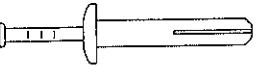
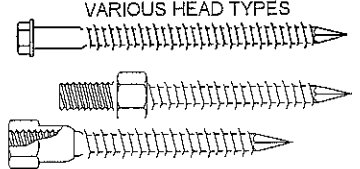
ANCHOR SCHEDULE

ANCHOR SPACING vs DESIGN PRESSURE AND CONNECTION TYPE			UP TO 81.5 PSF										UPTO 91.4 PSF										
			POURED CONCTETE					CONCRETE BLOCK					POURED CONCTETE					CONCRETE BLOCK					
			CONECTION TYPE					CONECTION TYPE					CONECTION TYPE					CONECTION TYPE					
ANCHOR TYPE	PANEL	E.D.	A	B	C	D	E	A	B	C	D	E	A	B	C	D	E	A	B	C	D	E	
 1/4" RAWL LOK/BOLT (SLEEVE ANCHOR) 1 1/8" MIN. EMBEDMENT	68" SPAN	3"	15	10	6	13	13	16	10	7	13	13	13	7	5	9	11	13	7	6	9	11	
		2"	14	9	5	13	13	14	9	6	13	13	12	6	4	8	9	12	6	5	8	10	
		1 1/4"	12	8	4	12	12	12	8	4	12	12	11	5	3	7	9	11	5	4	7	9	
	88" SPAN	3"	12	4	5	6	5	12	5	5	6	5	11	3	4	5	3	11	4	5	5	3	
		2"	11	4	4	5	4	11	4	4	5	5	9	3	3	4	3	10	3	4	4	3	
		1 1/4"	10	4	3	5	4	10	4	3	5	4	9	3	3	4	3	9	3	3	4	3	
	105" span	3"																					
		1 1/4"																					
	123" span	3"																					
		2"																					
		1 1/4"																					
	 1/4" RAWL ZAMAC NAILIN DRIVE (HAMMER DRIVE) 1 3/8" MIN. EMBEDMENT IN CONCRETE 1 1/4" MIN. EMBEDMENT IN BLOCK	68" SPAN	3"	13	8	5	12	13	9	6	4	9	9	11	5	5	8	9	8	4	4	6	7
2"			11	7	5	11	11	8	5	4	8	8	10	5	4	7	8	8	4	3	5	6	
1 1/4"			10	7	4	10	10	8	5	3	7	8	9	4	3	6	7	7	3	3	4	5	
88" SPAN		3"	10	4	4	5	4	7	3	3	4	3	9	3	4	4	3	7		3	3		
		2"	9	3	3	4	4	7		3	3	3	8	3	3	3		6		3			
		1 1/4"	8	3	3	4	3	6		3	3		7		3	3		5					
105" span		3"																					
		1 1/4"																					
123" span		3"																					
		1 1/4"																					
 VARIOUS HEAD TYPES (MASONRY SCREWS) 1/4" RAWL PERMA-SEAL TAPPER 1/4" ELCO PANEL MATES 1 1/2" MIN. EMBEDMENT IN CONCRETE 1 1/4" MIN. EMBEDMENT IN BLOCK		68" SPAN	3"	16	13	8	13	13	11	7	5	11	11	16	8	7	12	13	10	5	4	7	8
			2"	16	11	7	13	13	10	6	4	10	10	16	8	6	10	12	9	4	4	6	7
	1 1/4"		16	10	6	13	13	9	6	3	9	9	14	7	5	9	11	8	4	3	5	6	
	88" SPAN	3"	15	6	6	8	6	9	3	4	4	4	14	4	6	6	4	8	3	3	3	3	
		2"	14	5	5	7	6	8	3	3	4	3	12	4	5	5	4	7		3	3		
		1 1/4"	12	5	4	6	5	7	3	3	4	3	11	4	4	5	3	6			3		
	105" span	3"																					
		1 1/4"																					
	123" span	3"																					
		1 1/4"																					
	 1/4-20 x 7/8", 1/2" DIA. RAWL CALK-IN (MACHINE SCREW ANCHOR) 7/8" MIN. EMBEDMENT	68" SPAN	3"	16	13	9	13	13	11	7	5	11	11	16	10	8	13	13	10	5	4	7	8
			2.5"	16	13	7	13	13	10	7	4	10	10	16	9	7	13	13	9	4	4	6	7
2"			16	12	6	13	13	9	6	3	9	9	16	8	5	12	13	8	4	3	5	6	
88" SPAN		3"	16	7	7	9	8	9	3	4	4	4	16	5	6	7	5	8	3	3	3	3	
		2.5"	15	6	6	8	7	8	3	3	4	3	15	5	5	6	5	7		3	3		
		2"	15	6	4	8	6	7	3	3	4	3	13	4	4	6	4	6			3		
105" span		3"																					
		2.5"																					
123" span		3"																					
		2"																					

NOTES:

SPANS AND LOADS SHOWN IN THIS SCHEDULE ARE FOR DETERMINING ANCHOR SPACING ONLY. FOR ALLOWABLE SPANS VS. DESIGN LOADS REFER TO SHEET 4.

MINIMUM ENBEDMENT AND EDGE DISTANCE EXCLUDES STUCCO AND/OR WALL FINISHES.

SHADED AREAS REPRESENT ANCHOR CONDITIONS THAT ARE NOT ACCEPTABLE.

IT SHALL BE THE RESPONSIBILITY OF THE CONTRACTOR TO VERIFY THE SOUNDNESS OF THE STRUCTURE TO WITH STAND THE ADDITIONAL LOADS AND INSURE PROPER ANCHORAGE. SHUTTER SYSTEM MAY BE INTSALL INTO WOOD, CONCRETE OR MASONRY.

REVISIONS	BY
09/11/98	SP
01/06/06	SP
01/16/14	SP

RAMMS ENGINEERING, INC.
Structural Design
 2100 W. 76th STREET, SUITE 311
 HIALEAH, FLORIDA 33016
 EB 0006024

MAXIMUM IMPACT .050 ALUMINUM STORM PANEL
SHUTTER-TECH, INC.
 7485 W. SECOND CT. HIALEAH, FL 33014

BUILDING CODE COMPLIANCE



DRAWN SEP/JRB/RSM APPROVED
DATE: 01/10/98
SCALE: SHOWN
JOB: 98002
SHEET: 6

PRODUCT REVISED
 as complying with the Florida
 Building Code
 Acceptance No. 17-0925.04
 Expiration Date 10/22/2022
 By: *Hegha*
 Miami Design Product Control

Monsour
 9/11/17

ROBERT S. MONSOUR, PE
 EB-0006024
 RAMMS ENGINEERING, INC.

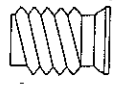
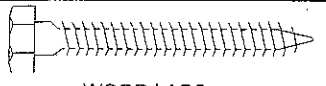
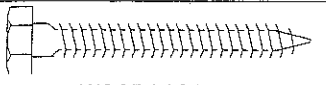
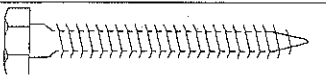
ANCHOR SCHEDULE

WOOD APPLICATIONS			UP TO 59.5 PSF					UP TO 71.5 PSF					UP TO 81.5 PSF					UP TO 91.4 PSF				
ANCHOR TYPE	DIA.	SPAN	CONNECTION TYPE					CONNECTION TYPE					CONNECTION TYPE					CONNECTION TYPE				
			A	B	C	D	E	A	B	C	D	E	A	B	C	D	E	A	B	C	D	E
 BRASS WOOD BUSHING 1" MIN. PENETRATION	1/4-20	68" SPAN	14	13	5	13	13	12	12	5	12	12	10	7	4	10	10	9	4	4	6	7
		88" SPAN	11	8	4	11	11	9	4	3	6	7	8	3	3	4	3	7		3	3	
		105" SPAN	9	4	4	6	7	8	3	3	4	3										
		123" SPAN	8	3	3	4	3															
 WOOD LAGS 1" MINIMUM TREAD PENETRATION	1/4"	68" SPAN	16	13	8	13	13	15	13	6	13	13	14	9	6	13	13	12	6	5	8	9
		88" SPAN	14	11	6	13	13	12	6	5	8	9	10	4	4	5	4	9	3	4	4	3
		105" SPAN	12	6	5	8	9	10	4	4	5	4										
		123" SPAN	10	4	3	5	4															
 WOOD LAGS 1" MINIMUM TREAD PENETRATION	5/16"	68" SPAN	16	13	10	13	13	16	13	8	13	13	16	10	7	13	13	14	7	6	9	11
		88" SPAN	16	13	7	13	13	14	7	6	9	10	12	5	5	6	5	11	4	5	5	3
		105" SPAN	14	7	6	9	10	12	4	5	6	4										
		123" SPAN	12	4	5	6	4															
 WOOD LAGS 1" MINIMUM TREAD PENETRATION	3/8"	68" SPAN	16	13	11	13	13	16	13	9	13	13	16	12	8	13	13	16	8	7	11	13
		88" SPAN	16	13	9	13	13	16	8	7	10	12	14	5	6	7	6	13	4	6	5	4
		105" SPAN	16	8	7	11	12	14	5	6	6	5										
		123" SPAN	13	5	6	6	5															
 WOOD LAGS 1" MINIMUM TREAD PENETRATION	7/16	68" SPAN	16	13	12	13	13	16	13	10	13	13	16	13	9	13	13	16	9	8	12	13
		88" SPAN	16	13	9	13	13	16	8	8	12	13	16	6	7	8	7	14	5	6	6	4
		105" SPAN	16	9	8	12	13	15	5	7	7	6										
		123" SPAN	15	5	7	7	6															

NOTES:

SPANS AND LOADS SHOWN IN THIS SCHEDULE ARE FOR DETERMINING ANCHOR SPACING ONLY. FOR ALLOWABLE SPANS VS. DESIGN LOADS REFER TO SHEET 4.

WHEN ANCHORING TO WOOD, THE WOOD MUST BE A MINIMUM 2 X 4 EQUAL TO #2 SOUTHERN PINE 0.55 SPECIFIC GRAVITY AND STRUCTURALLY PART OF THE FRAMING STRUCTURE OR SECURELY ATTACHED TO FRAMING STRUCTURE

SHADED AREAS REPRESENT ANCHOR CONDITIONS THAT ARE NOT ACCEPTABLE.

IT SHALL BE THE RESPONSIBILITY OF THE CONTRACTOR TO VERIFY THE SOUNDNESS OF THE STRUCTURE TO WITH STAND THE ADDITIONAL LOADS AND INSURE PROPER ANCHORAGE. SHUTTER SYSTEM MAY BE INSTALLED INTO WOOD, CONCRETE OR MASONRY.

PRODUCT REVISED
as complying with the Florida
Building Code
Acceptance No 17-0925.04
Expiration Date 10/22/2022
By *Heidi A. Mohr*
Miami Dade Product Control

Monsour
01/10/17

ROBERT S. MONSOUR, PE
EB-0006024
RAMMS ENGINEERING, INC.

BUILDING CODE COMPLIANCE

REVISIONS	BY
09/11/98	SP
01/06/06	SP
01/16/14	SP

RAMMS ENGINEERING, INC.
Structural Design
2100 W. 76th STREET, SUITE 311
HIALEAH, FLORIDA 33016
EB 0006024

MAXIMUM IMPACT .050 ALUMINUM STORM PANEL
SHUTTER-TECH, INC.
7485 W. SECOND CT. HIALEAH, FL 33014

DRAWN
SEP/JRB/RSM
APPROVED
DATE
01/10/98
SCALE
SHOWN
OR
98002
SHEET
7
7 SHEETS